

Publishing Tasks

The DRAW TABLE tool can be used to create detailed publishing documents. This is where you layout a page into blocks and insert text and/or graphics into those blocks. To illustrate Word's publishing capabilities the following document will be created.

This Week's Specials

PARRY AND SYKES

REAL ESTATE

<p style="text-align: center; margin: 0;">HIGHTON</p> <p>Just listed, this sound home offers 4 good-sized bedrooms, comfortable lounge, central kitchen, plus family room. Excellent parking makes this a most appealing home. Call now for your inspection.</p> <p style="text-align: center;">Asking only \$328,000</p>	<p style="text-align: center; margin: 0;">BELMONT</p> <p>Delightful BV home in a most pleasant street, featuring 3 bedrooms each with BIR, study, updated kitchen, tastefully decorated lounge with a northerly aspect. Your inspection is highly recommended.</p> <p style="text-align: center;">Priced to sell at \$308,000</p>
<p style="text-align: center; margin: 0;">HIGHTON</p> <p>Low maintenance home in a quiet court handy to the Highton Shopping Centre. Very good condition inside and out with many internal improvements. New carpet, well established garden and double garage.</p> <p style="text-align: center;">Special price \$432,500</p>	<p style="text-align: center; margin: 0;">BELMONT</p> <p>Beautifully presented 3 BV home of 14 squares. All gas appliances, BIR in each bedroom, bathroom with vanity unit and separate shower recess. Outside there is a well established garden and double garage.</p> <p style="text-align: center;">Reduced to \$276,000</p>

225 High Street, Belmont, Ph 0352 438852

AH: Graeme Parry 0410 489259, Rebecca Sykes 0410 590389

The Thumbnail Sketch

Whenever you embark on a publishing task some prior planning of what you want your page to look like is necessary. Usually a rough sketch of the page is drawn on paper showing where you intend to place the text and graphics frames (cells). This sketch is called a THUMBNAIL SKETCH. A THUMBNAIL SKETCH (Table Layout) for the page you are about to create is shown below.

In this case you will be creating an A4 paper document. The measurements of the page are 21.0 cm across and 29.7 cm down. The normal margins are set to 2.54 cm which will leave a work area of about 15.92 cm across and 24.62 cm down. So long as we keep the table within these values, the table will print neatly on the one page. The cells that will contain data are labelled with letters in the TABLE LAYOUT diagram.

Page Margins

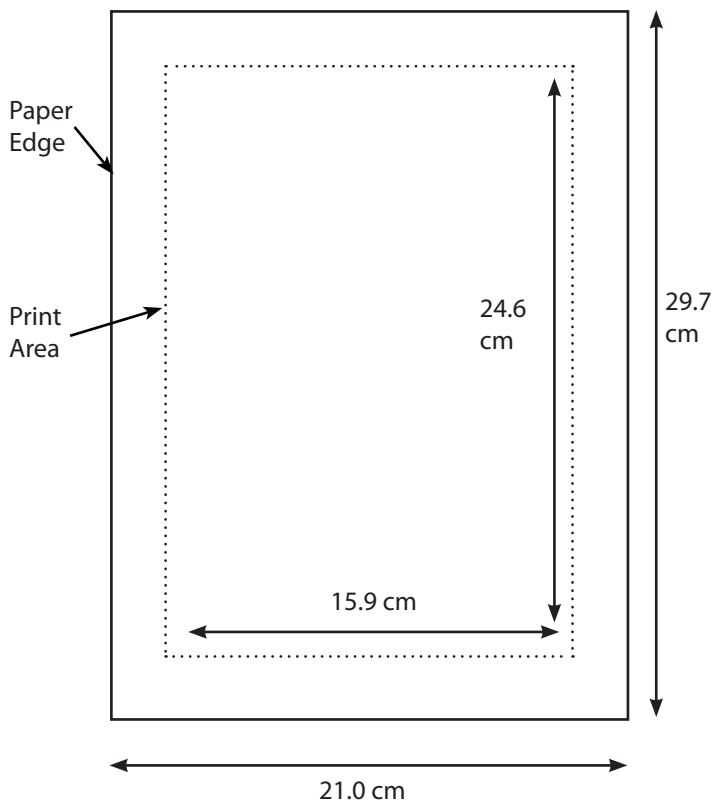
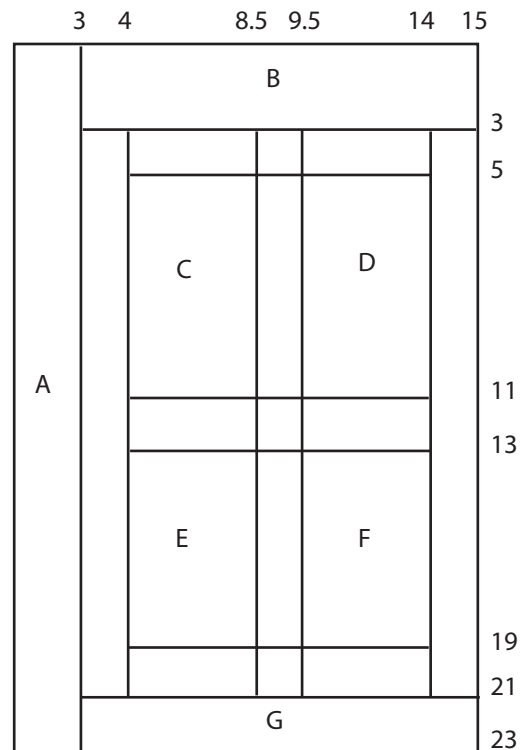

Table Layout



Page Setup

Before starting the publication the paper size and page margins need to be set.

- 1 Load Microsoft Word or close the current file and start a NEW BLANK DOCUMENT.

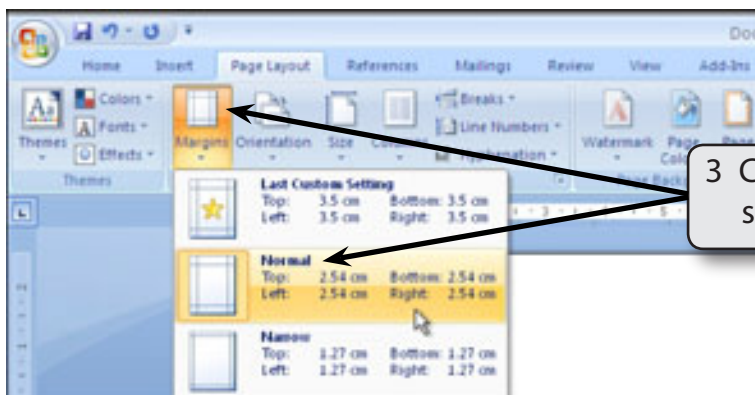
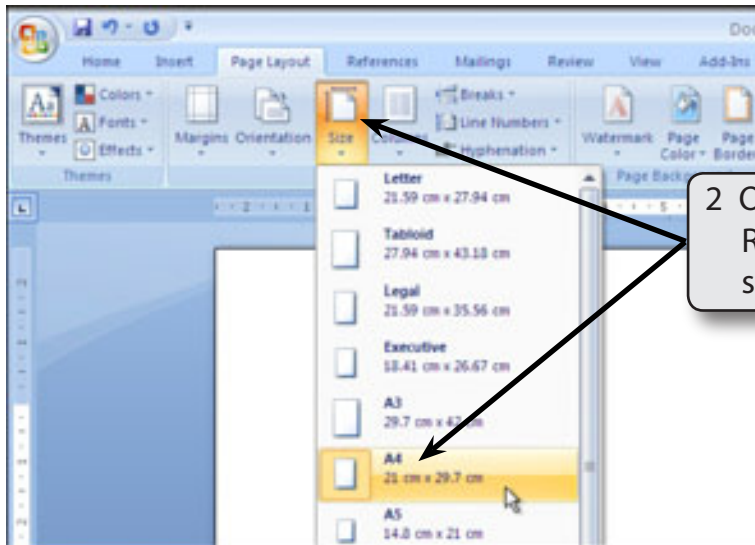

Laying out the Page

The first step in creating this type of publication is to place the cells in the required positions in the table.

A Showing the Text Boundaries

To assist with the laying out of the page the screen will be set to a reduced view and the text boundaries turned on so that the page margins can be seen.

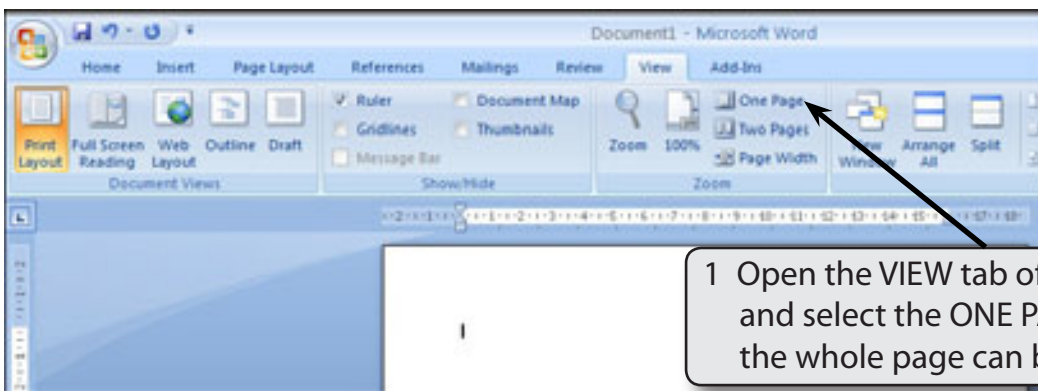

2 Click on the OFFICE BUTTON and select WORD OPTIONS.

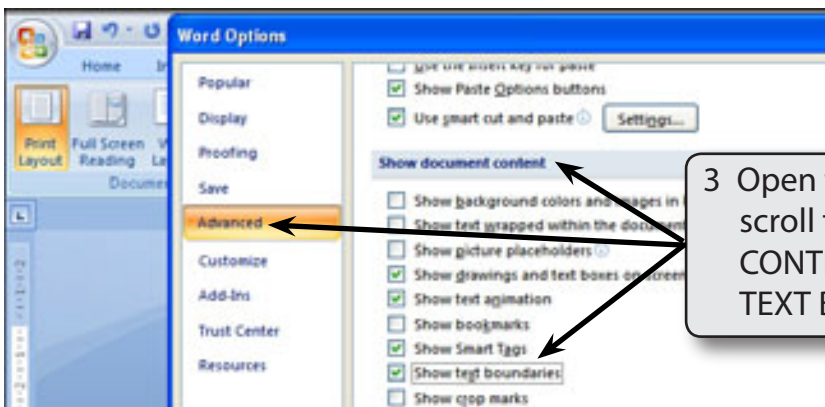

4 Select OK to return to the page.

B Drawing the Table

The table will be drawn using the DRAW TABLE tool so that it can be customised.

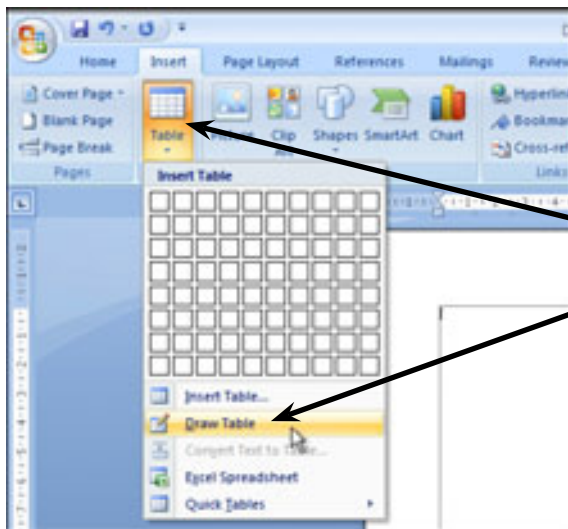

1 Open the INSERT tab of the RIBBON, select the TABLES icon and select DRAW TABLE.

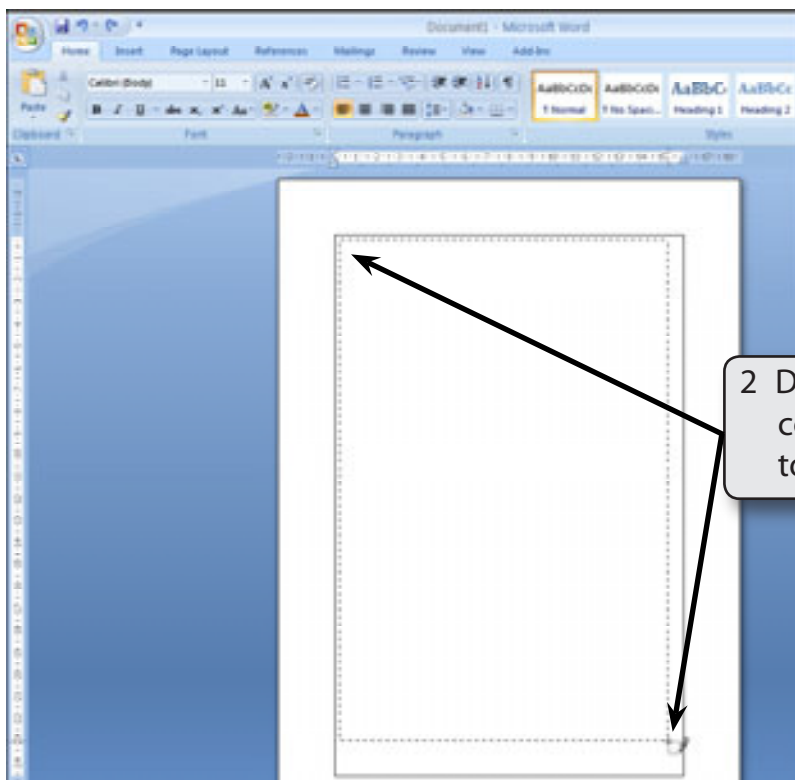

2 Drag a table from the top left corner of the page (at 0,0) across to 15.25 cm and down to 23.0 cm.

NOTE: A small amount of space is being left at the right and bottom margins to ensure that the table fits within the page.

